

DOĞALTAŞ MEKANİK SİSTEM

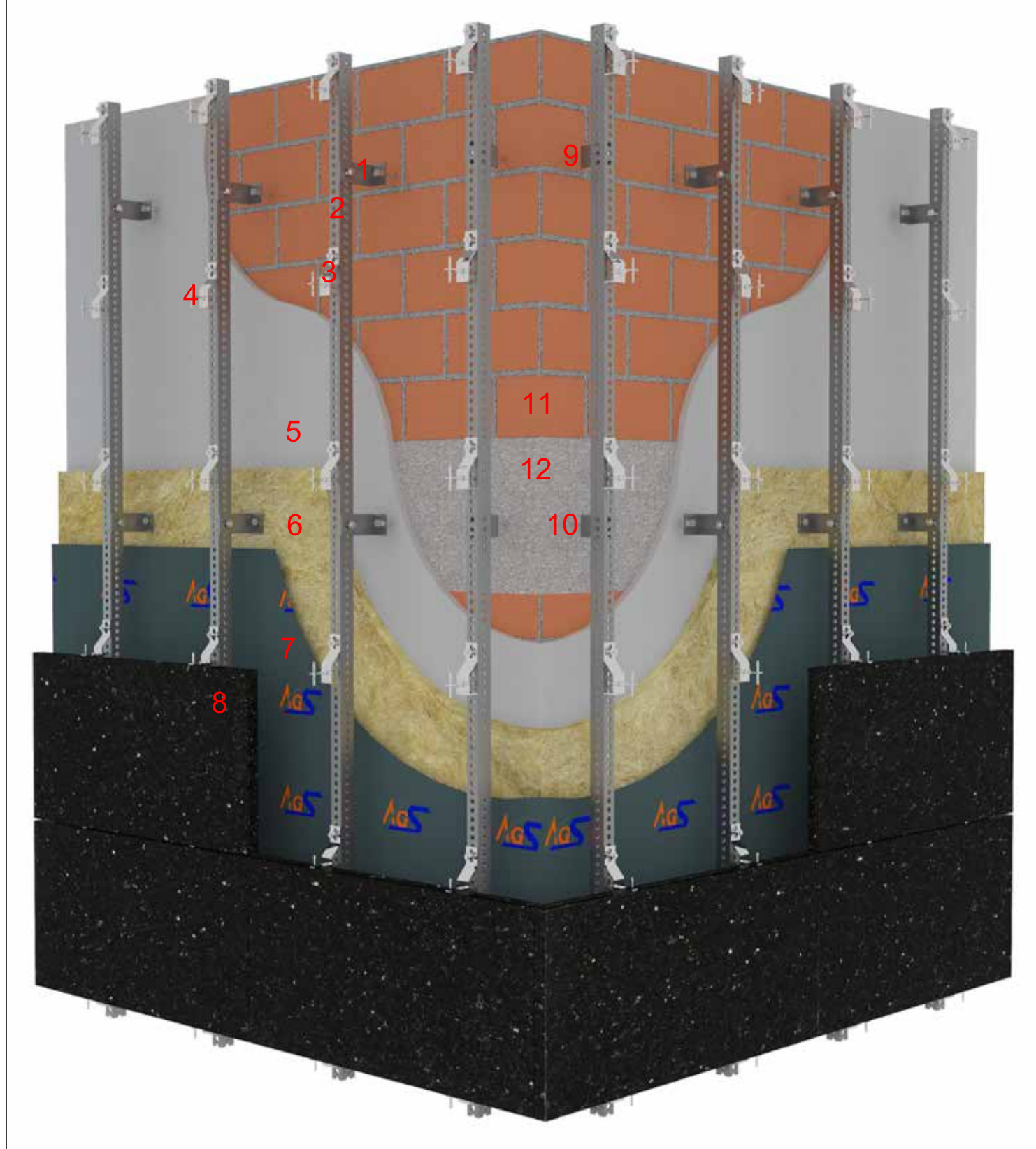

1. ÖZEL ÇELİK ANKRAJ
2. DÜŞEY PROFİL
3. H GÖVDE PARÇASI
4. PİM 5mm
5. SIVA
6. ISI YALITIMI
7. SU YALITIMI
8. DOĞALTAŞ
9. PLASTİK DÜBEL
10. ÇELİK DÜBEL
11. TAŞIYICI TUĞLA DUVAR
12. TAŞIYICI BETONARME KİRİŞ



DOĞALTAŞ MEKANİK SİSTEM

kod	profil	profil özellikleri	kod	profil	profil özellikleri
-----	--------	--------------------	-----	--------	--------------------

ÖZEL ÇELİK ANKRAJ

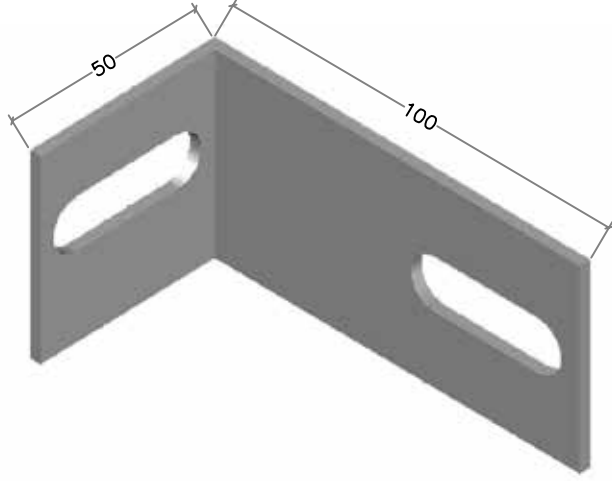

H GÖVDE PARÇASI

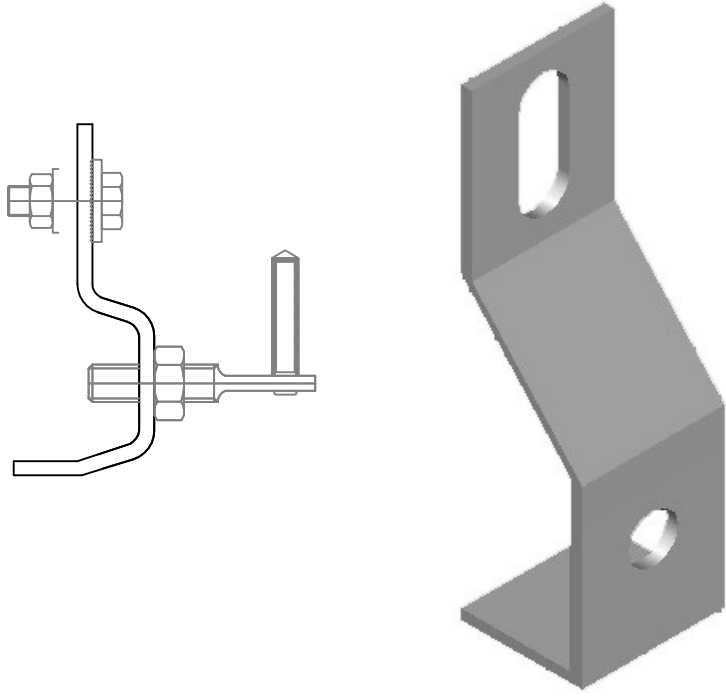

DÜŞEY PROFİL

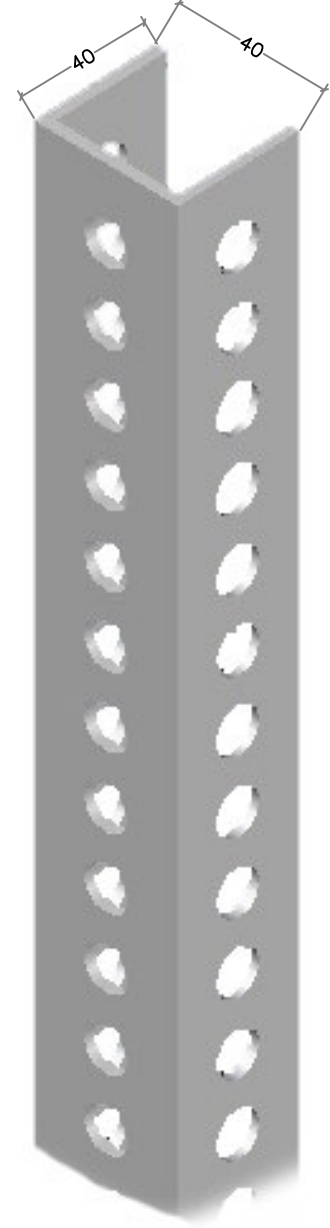

Civata

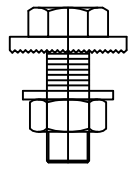

5mm PİM

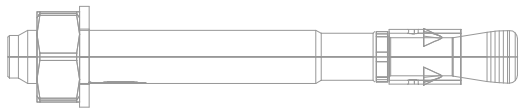
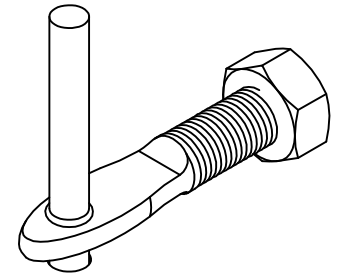
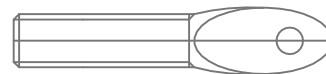

Çelik Dübel

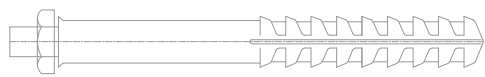

Plastik Dübel

DOĞALTAŞ MEKANİK SİSTEM

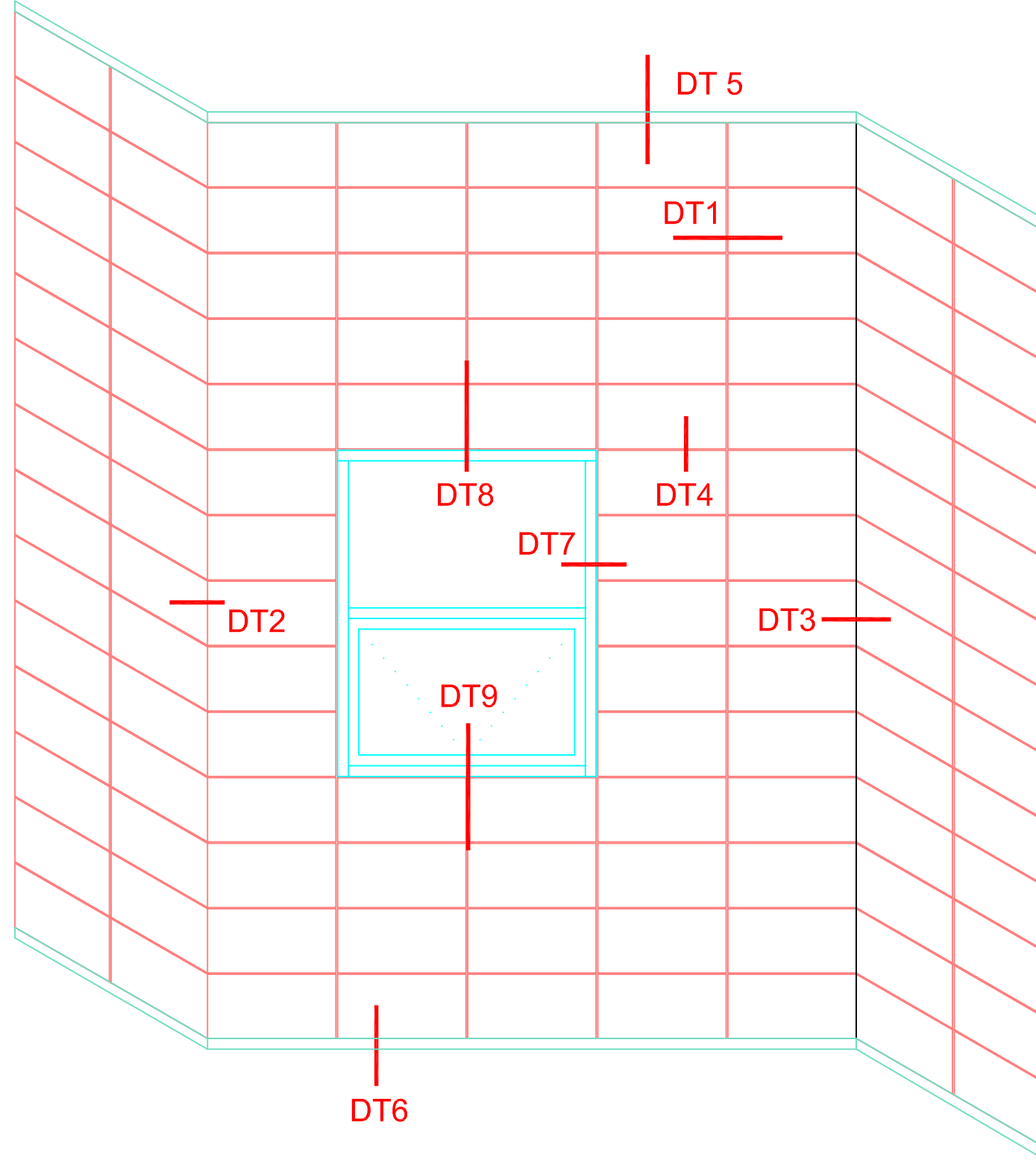

DOĞALTAŞ MEKANİK SİSTEM

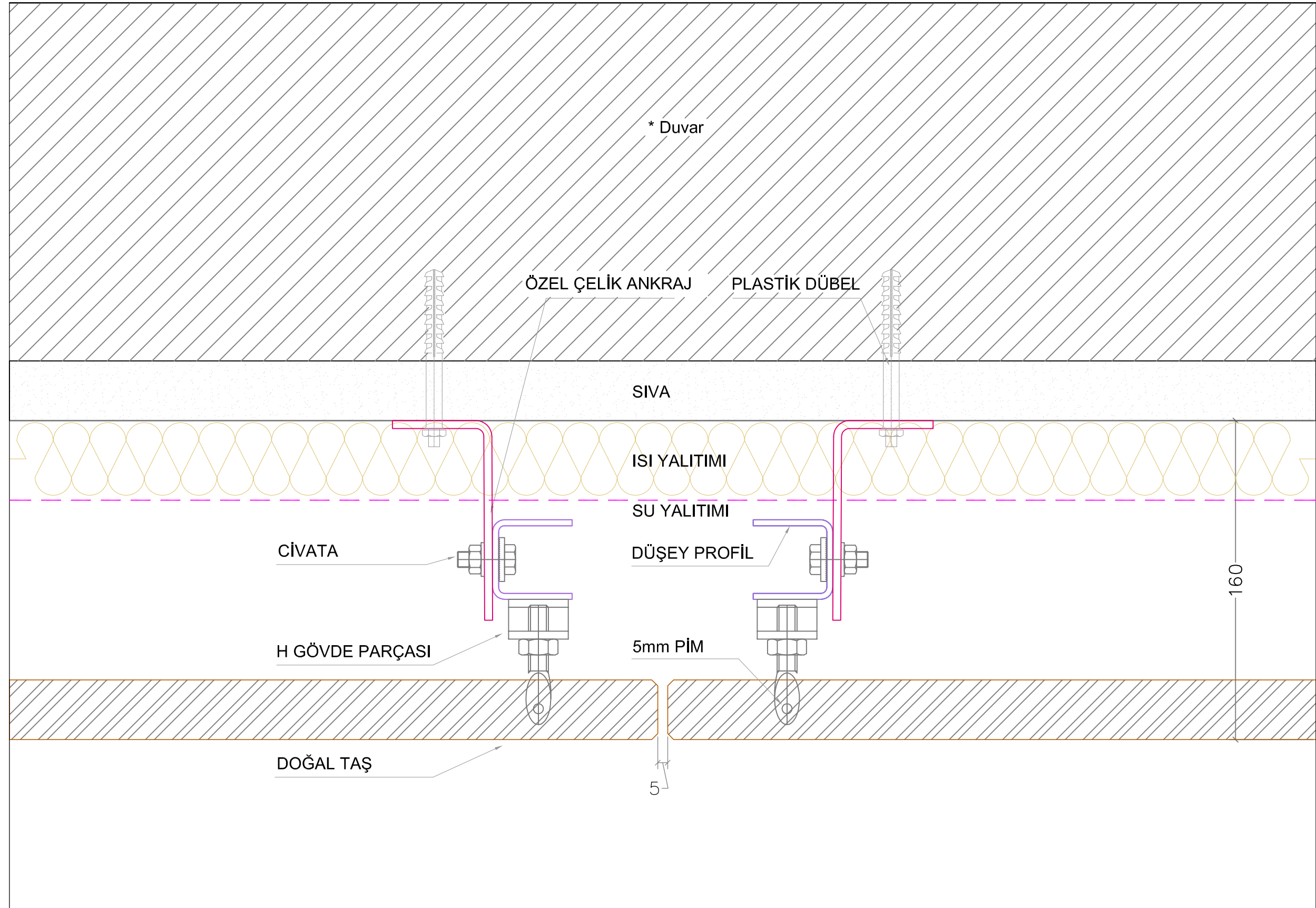

DOĞALTAŞ MEKANİK SİSTEM

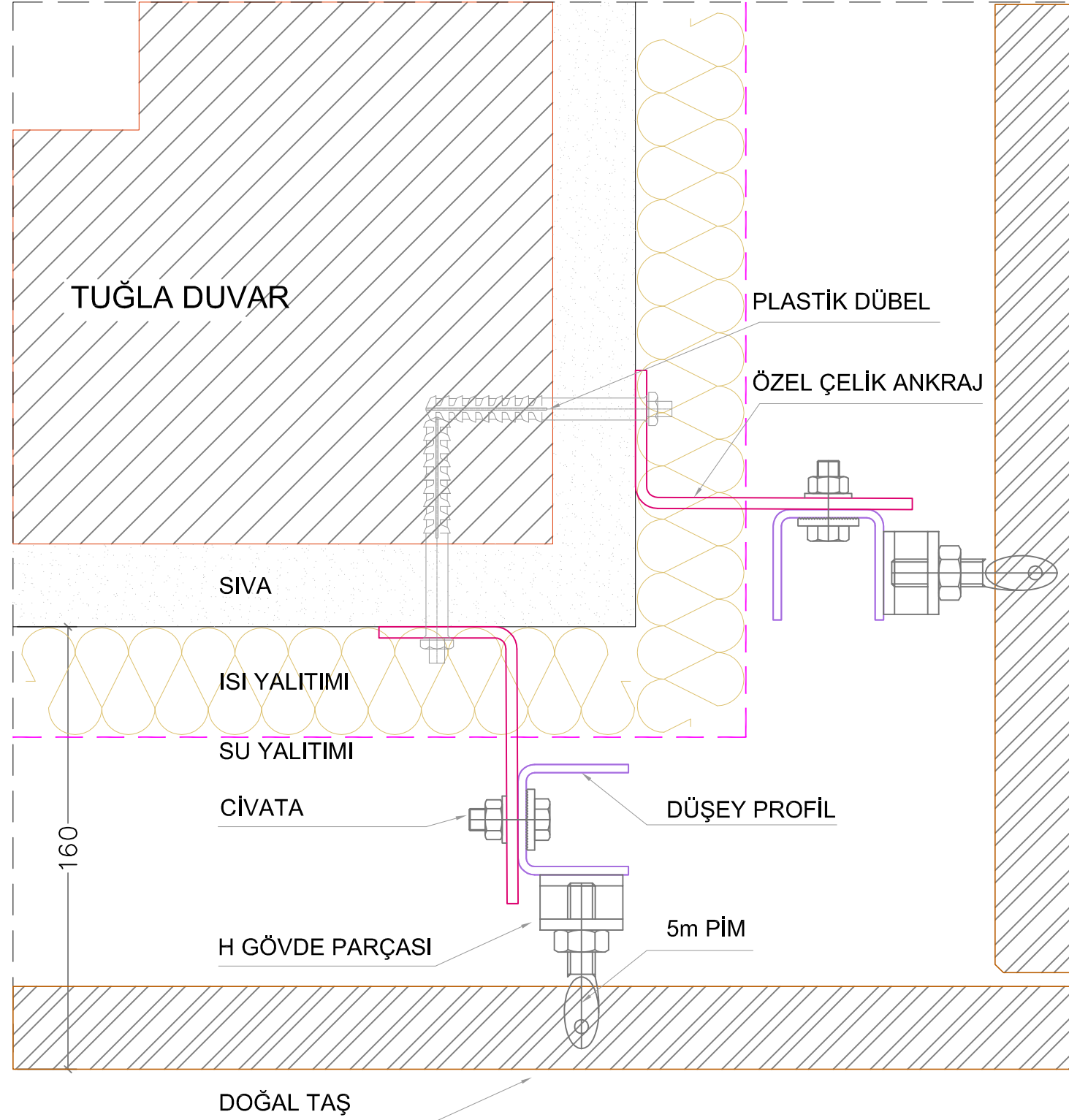

DOĞALTAŞ MEKANİK SİSTEM

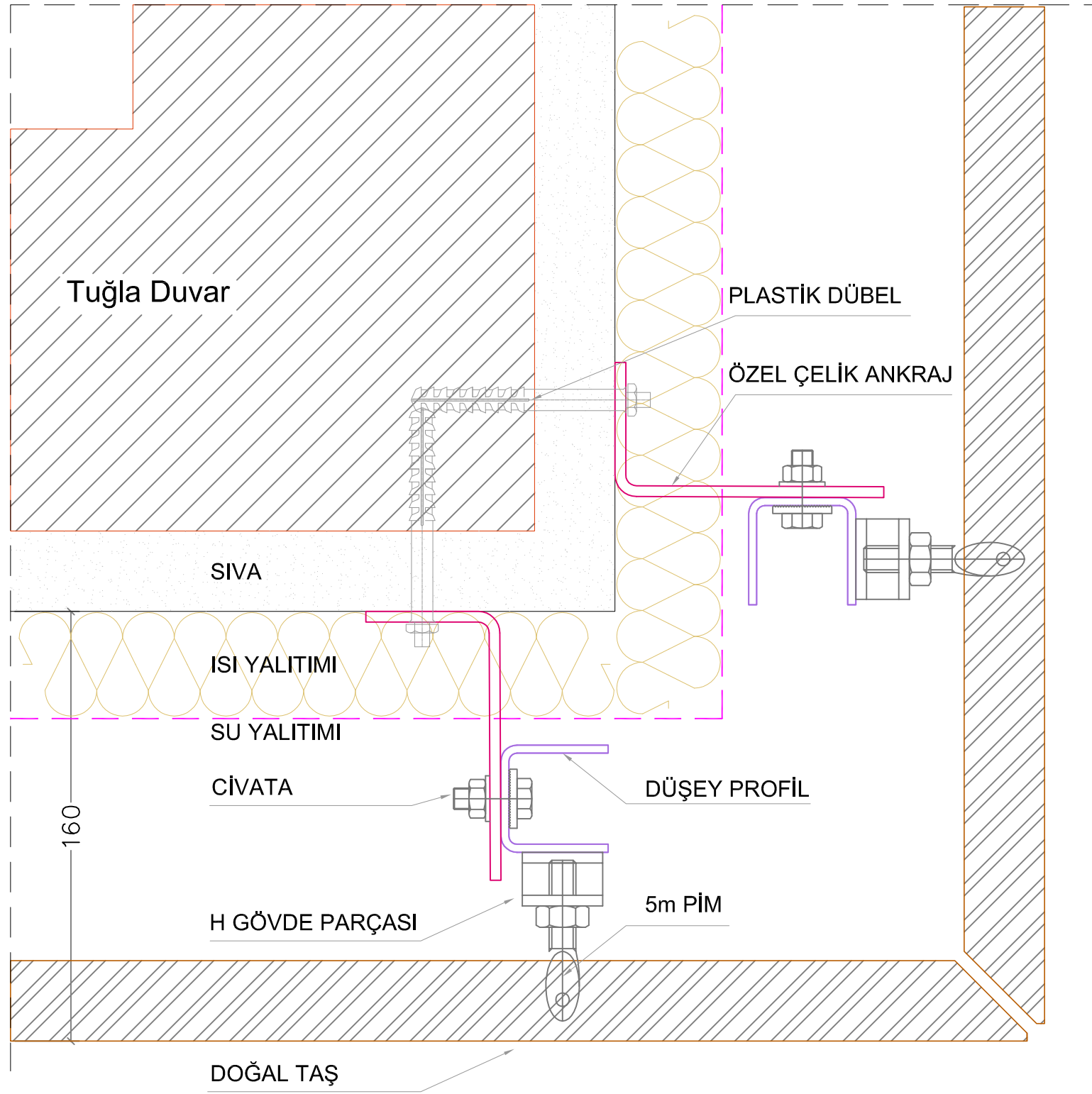

DOĞALTAŞ MEKANİK SİSTEM

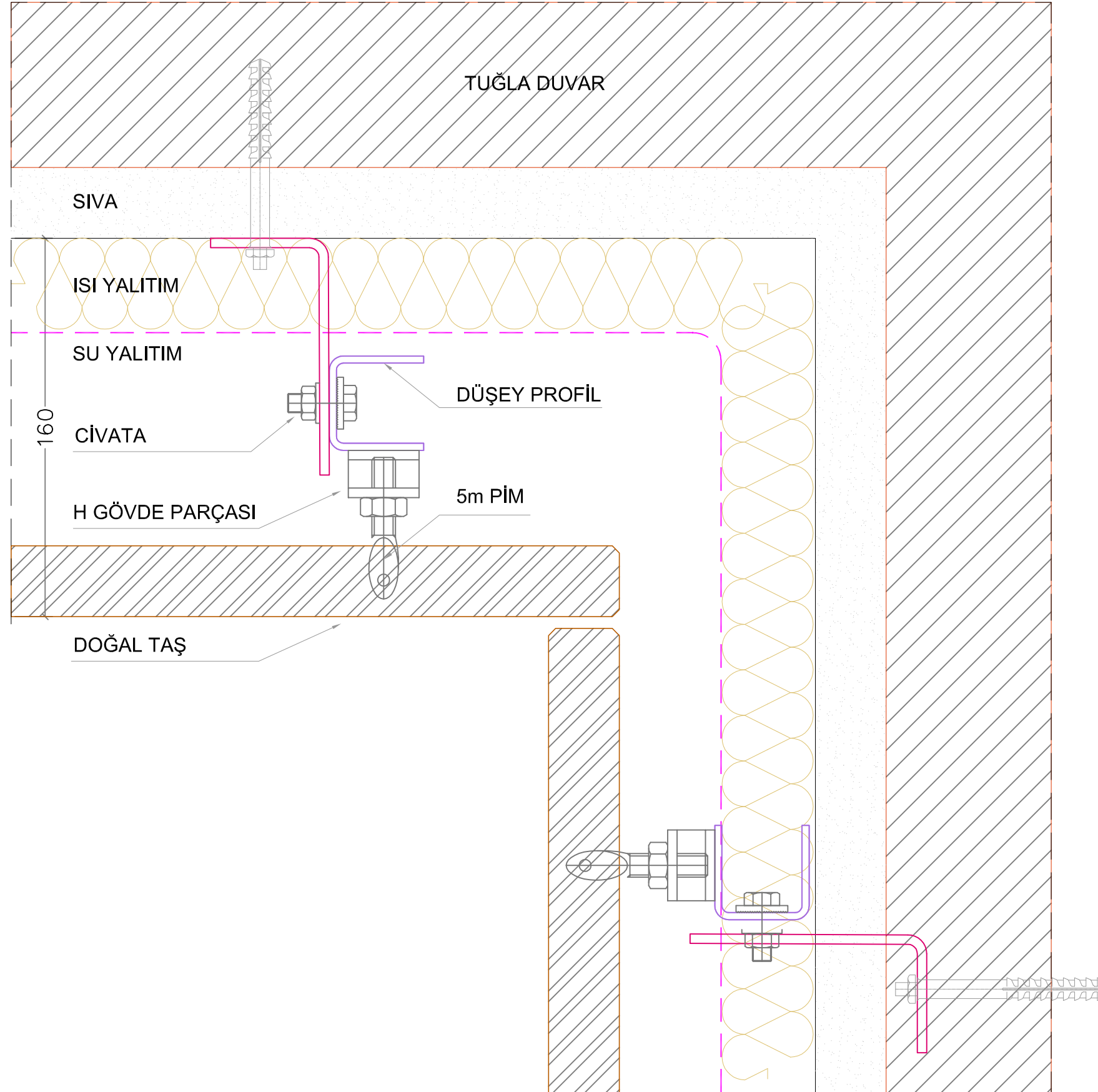

DOĞALTAŞ MEKANİK SİSTEM

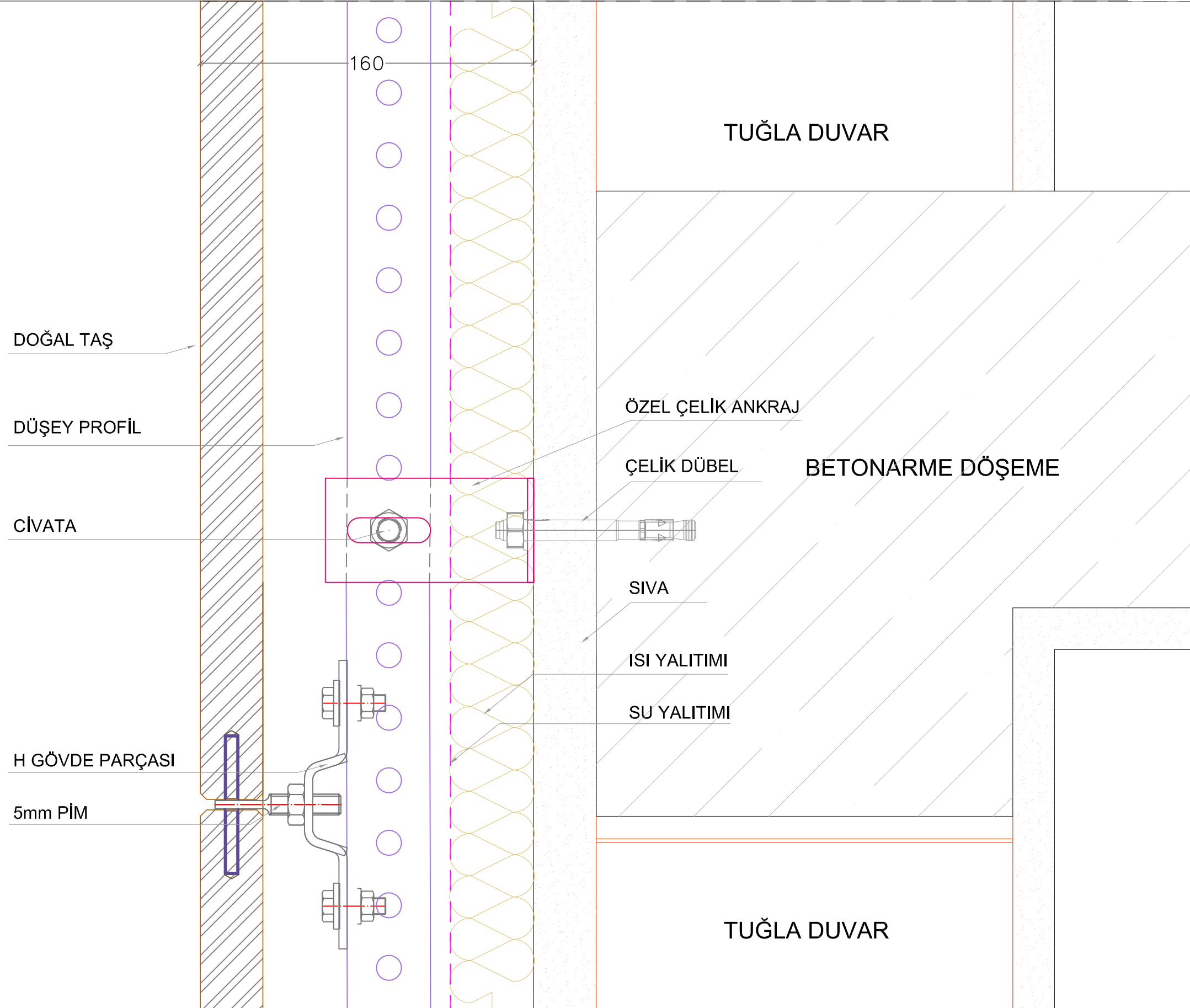

DOĞALTAŞ MEKANİK SİSTEM

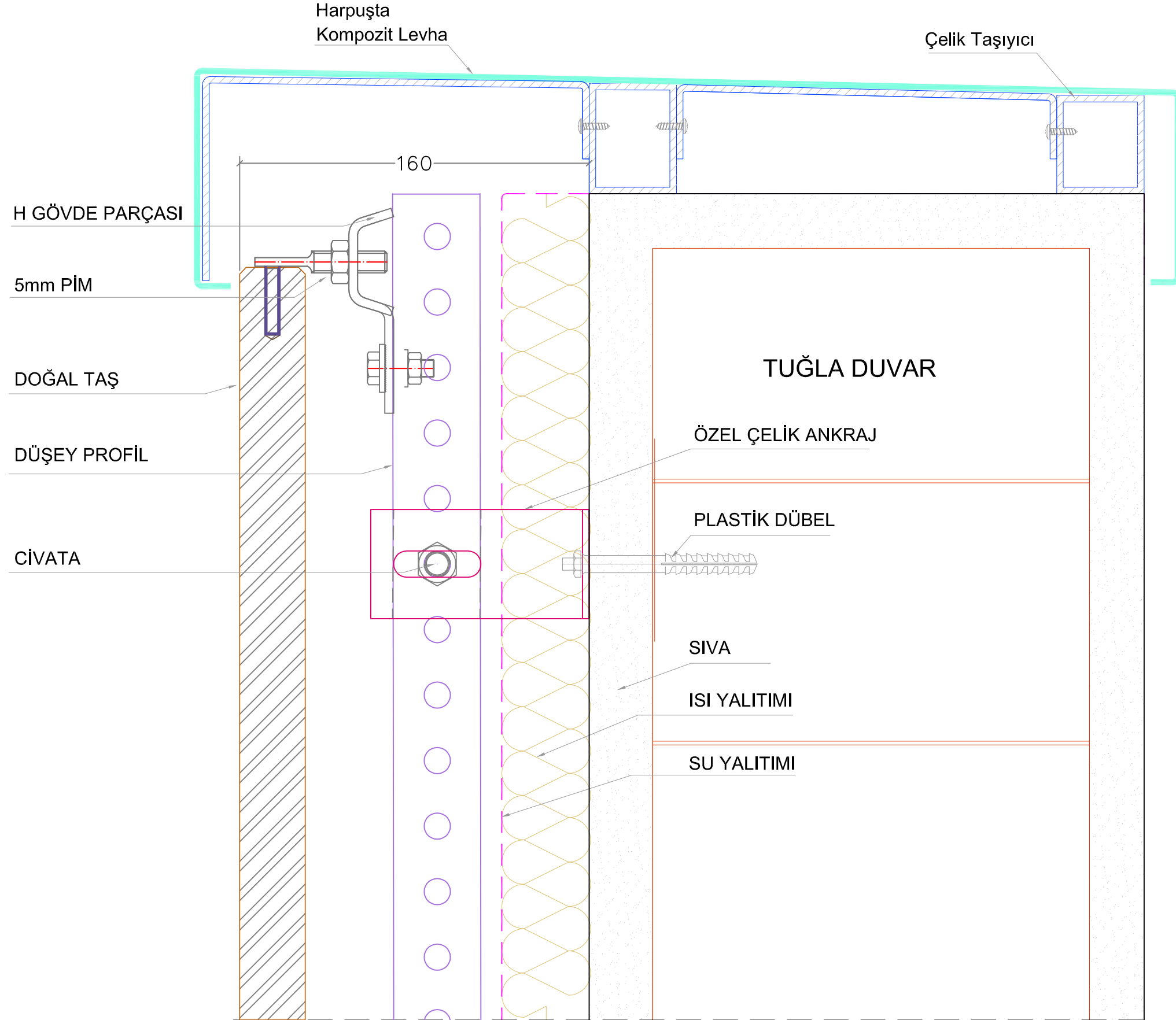

DOĞALTAŞ MEKANİK SİSTEM

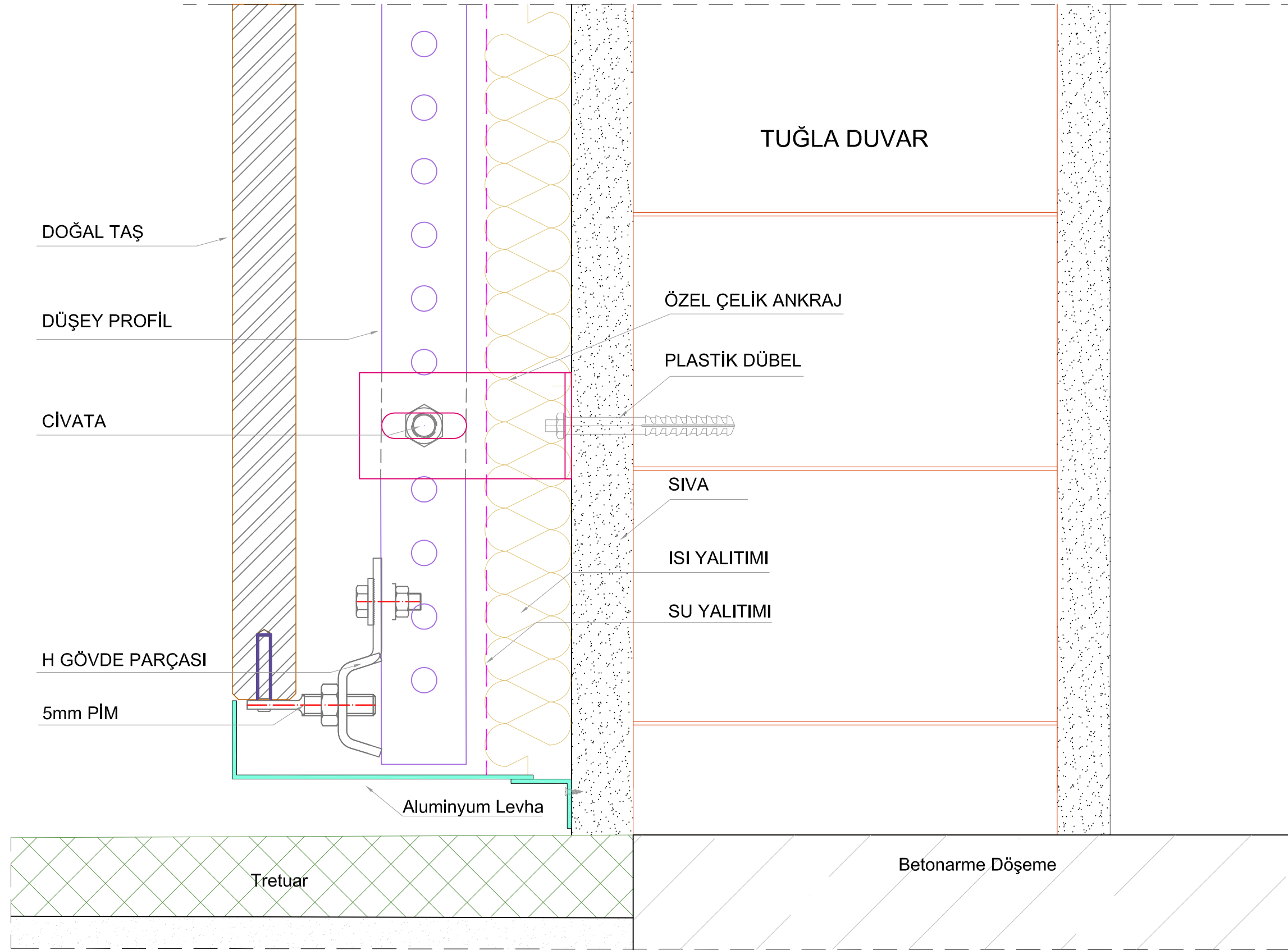

DOĞALTAŞ MEKANİK SİSTEM

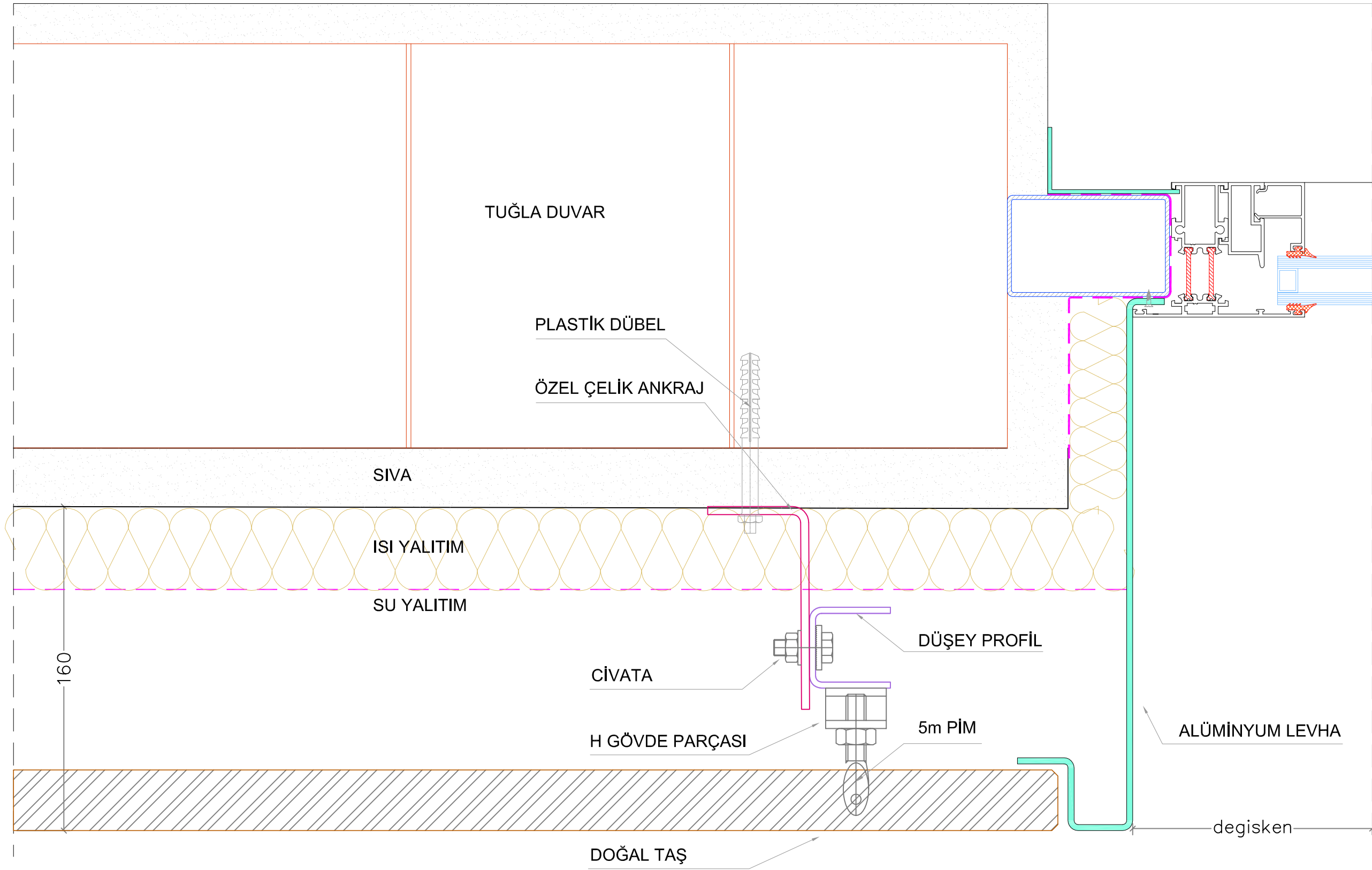

DOĞAL TAŞ MEKANİK SİSTEM

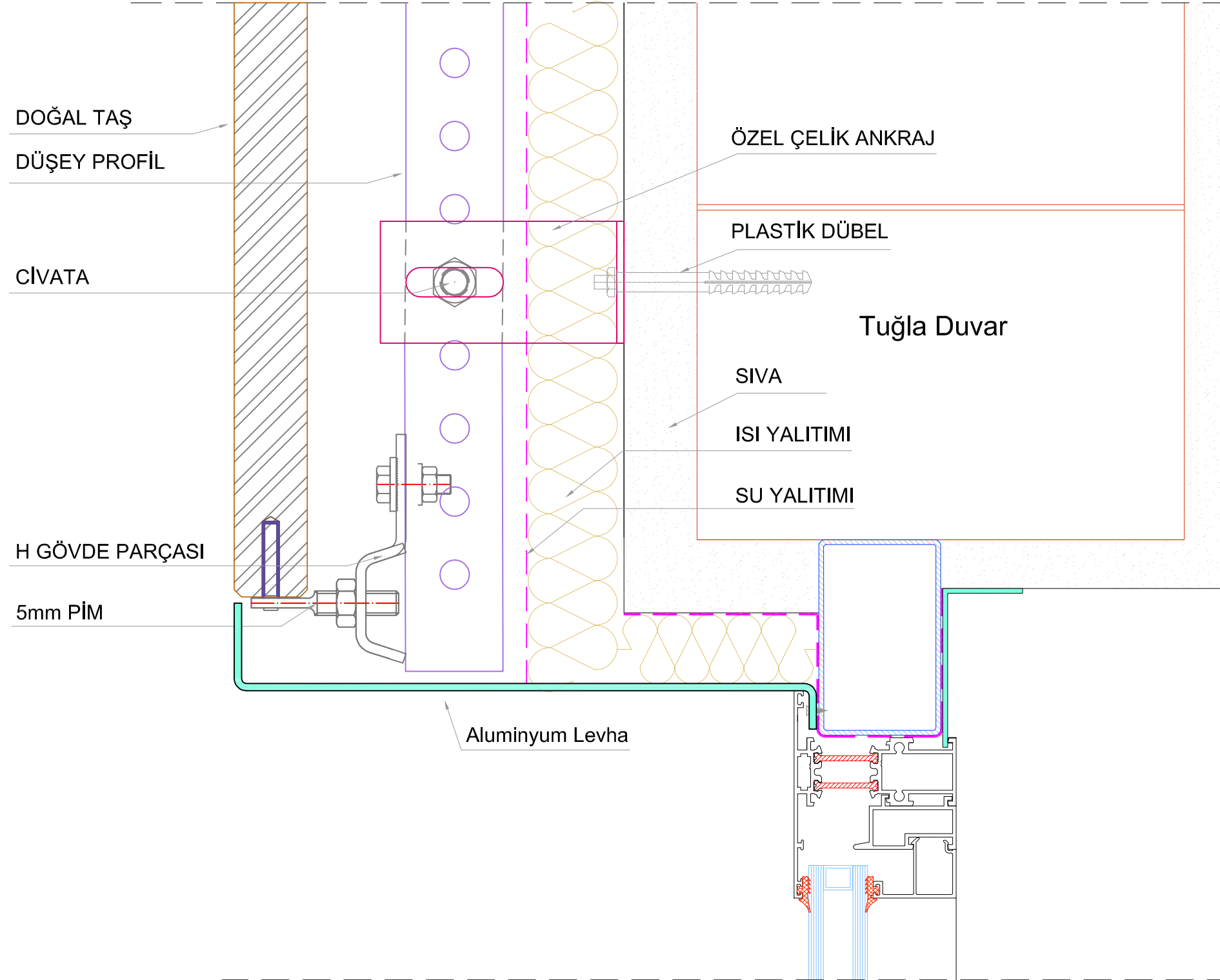

DOĞALTAŞ MEKANİK SİSTEM

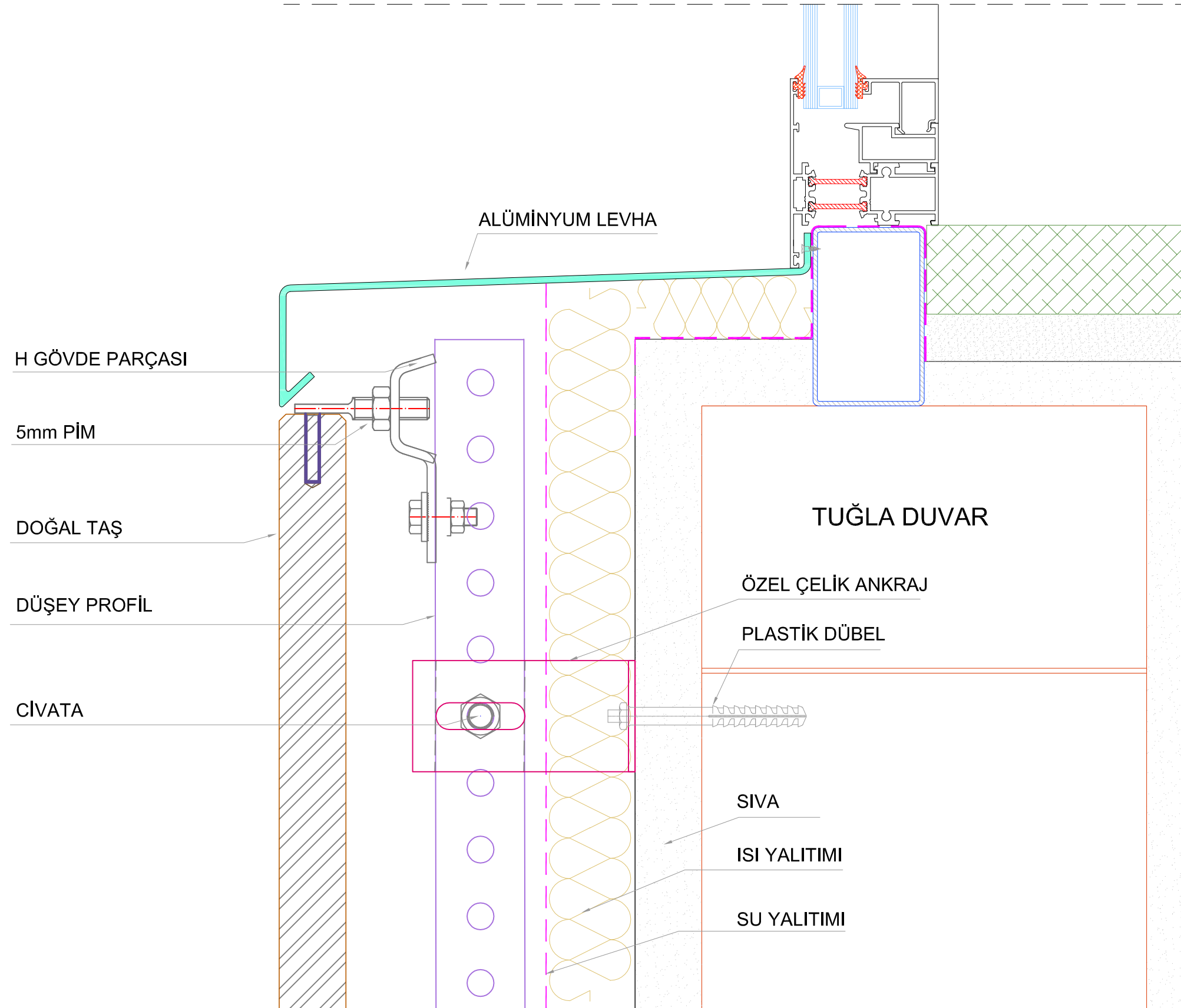

DOĞALTAŞ MEKANİK SİSTEM

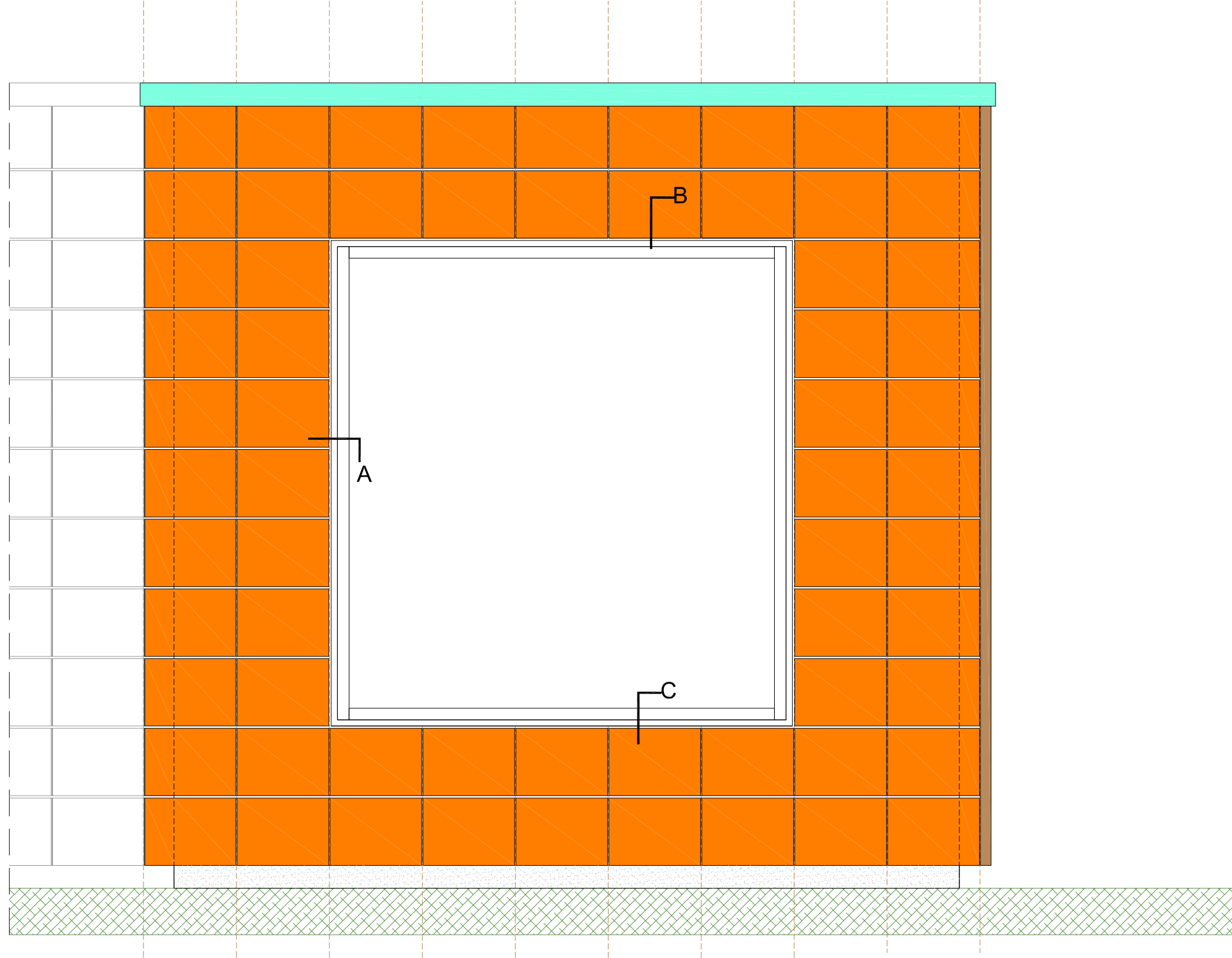

DOĞALTAŞ MEKANİK SİSTEM

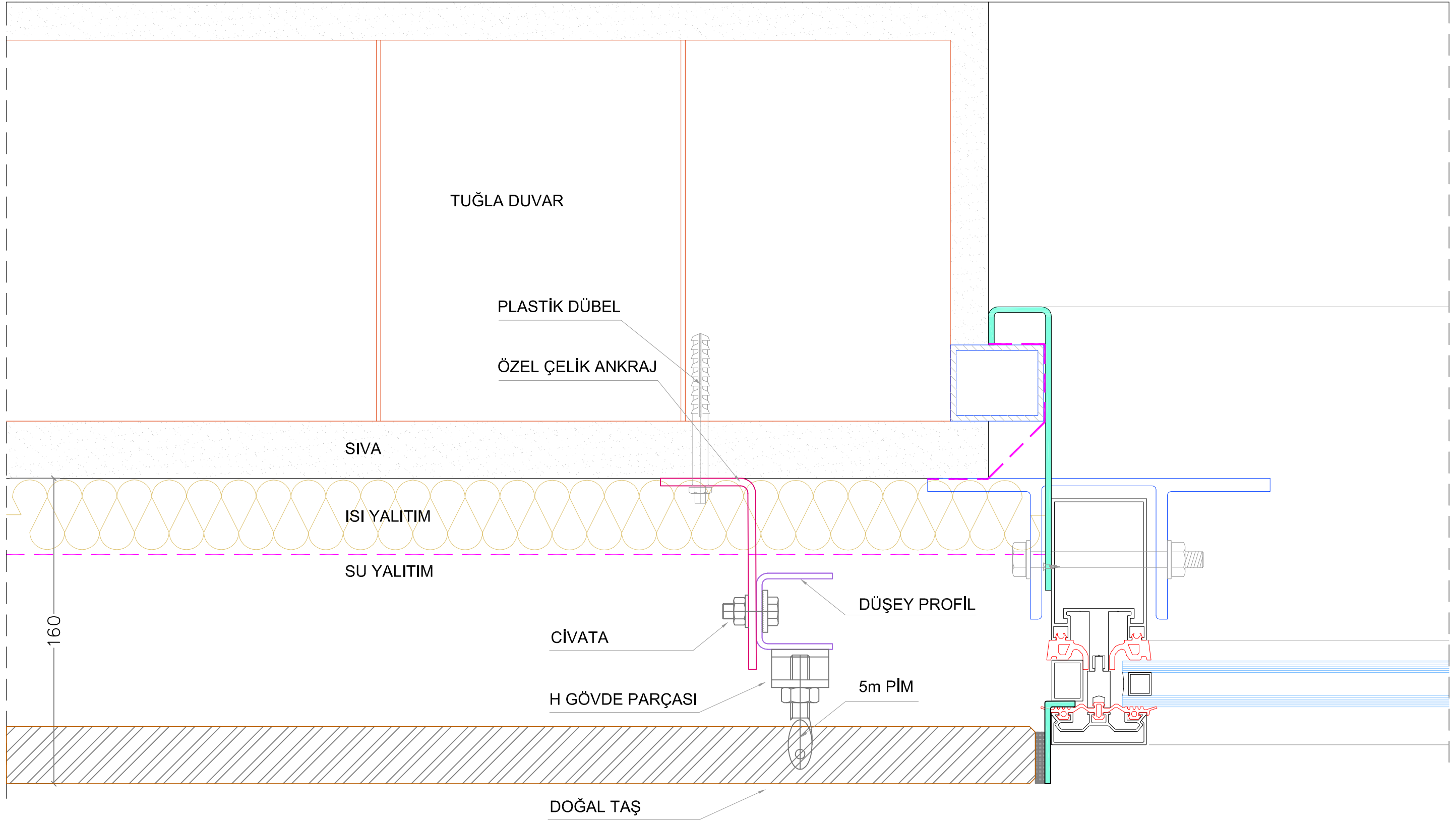

DETAY A

DOĞALTAŞ MEKANİK SİSTEM

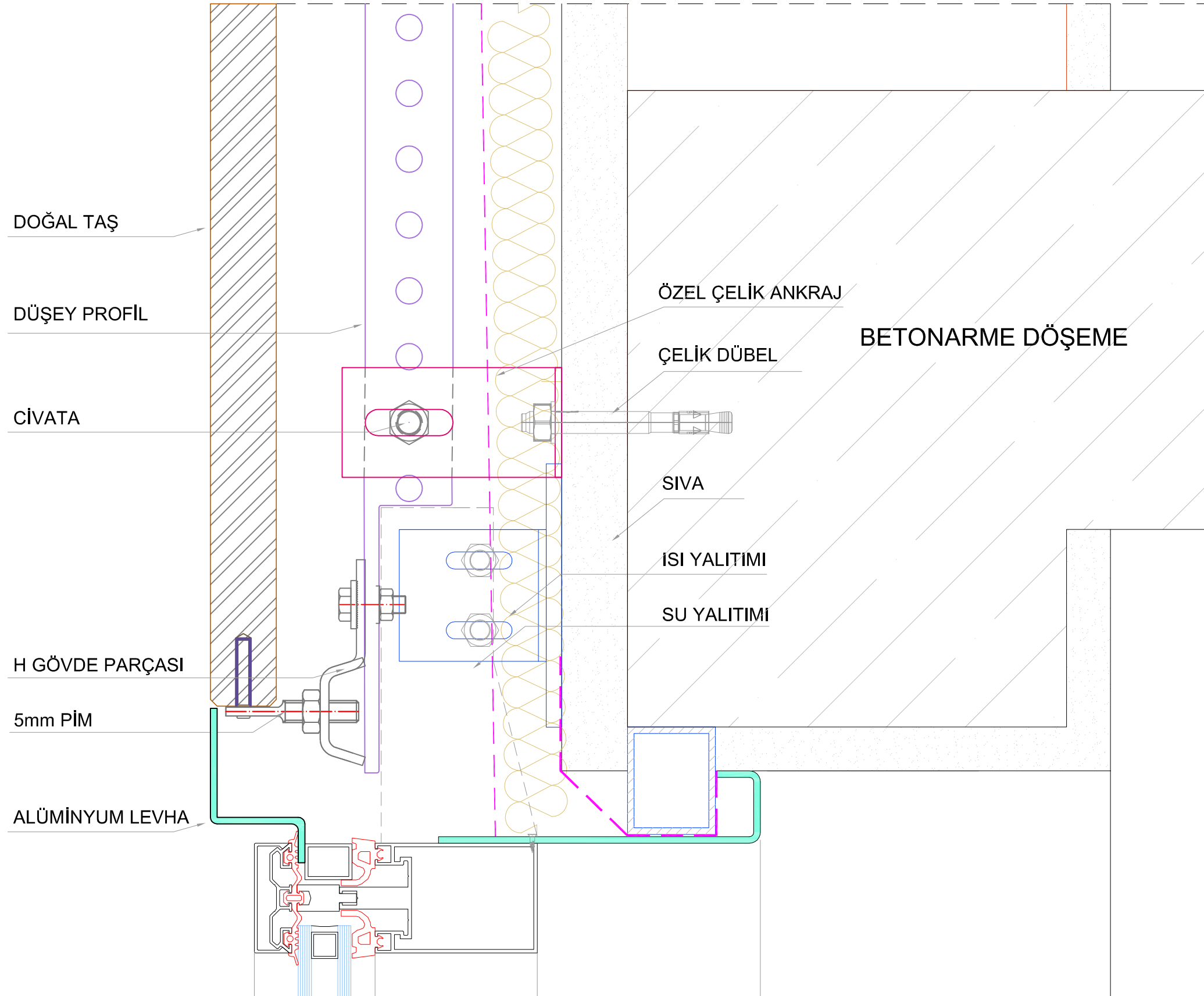

DETAY B

DOĞALTAŞ MEKANİK SİSTEM

